

your global specialist

Well-knit solutions for your success.

Speciality lubricants for the textile industry



Designed to your requirements	3
The right oil for your application	4
Oil change: how it's done	6
The rolling bearing – One of the most important machine elements in the textile industry	8
Lubricants for spinning machines	10
Lubricants for synthetic fibre spinning machines	12
Lubricants for synthetic fibre processing machines	14
Lubricants for twisting and spool winding machines	16
Lubricants for knitting machines	18
Lubricants for warp knitting machines	22
Lubricants for weaving machines	24
Lubricants for textile finishing machines	26
Lubricants for stenter frames	32
Lubricants for gears and electric motors in textile plants	36
Lubricants and other products for compressors	38
KlüberEfficiencySupport Services	40
The right lubricant at the right place at the right time	41

# Designed to your requirements

Textile machines and their components are subject to high stress. Constantly changing and often high loads, vibrations and varying operating conditions require tough equipment. External factors such as humidity and extreme temperature variations also play a role. Maintenance is an arduous task and is therefore carried out only at long intervals in many cases.

Selecting the right lubricant is therefore paramount – for the initial lubrication of a component as well as for relubrication during operation. After all, it is the lubricant that is responsible for ensuring the reliable operation of each machine element. The lubricants used are expected to offer reliable performance over a long service life and a wide temperature range as well as good resistance to loads. For the operators, these characteristics mean long relubrication intervals for greases and long lubricant life for oils.

As an expert for speciality lubricants, Klüber Lubrication cooperates closely with the original equipment manufacturers of major textile machine components to push the limits of what can be technically achieved even further: longer service intervals, longer component life and more reliable operation.

## Speciality product instead of just a lubricant

Have you ever considered the impact speciality lubricants could have on your operating costs? The lubricant itself constitutes only a minor investment, but its effects can be tremendous.

Klüber Lubrication knows exactly what the special requirements of the textile industry are. Our experts can assist you as consultants and development partners, both for existing components and for new components at the design stage. We offer you personal solutions that are designed to meet your needs and requirements: some of them are products that have been successfully used in the field for many years, while others are specially developed lubricants tested thoroughly on rigs and adjusted to your specific requirements.

## We are where you are

We know that the right product alone is not sufficient to meet your requirements. We want to be your preferred supplier of speciality lubricants. We are wherever you need us - our specialists are at your side worldwide. Safe, quick, flexible and reliable solutions are what Klüber Lubrication stands for.

## A test house that is unrivalled worldwide

When developing and testing our speciality lubricants, we take the specific requirements of the industry as a yardstick. Our unique test house offers more than 100 testing installations, some of which we have developed ourselves for particular testing purposes.

## Our certifications

Klüber Lubrication Location		ISO 9001	IATF 16949	ISO 14001
Europe	Austria	✓	✓	✓
	Belgium	✓	✓	✓
	Germany	✓	✓	✓
	Italy	✓		✓
	Spain	✓	✓	✓
	Turkey	✓		✓
America	Argentina	✓		✓
	Brasil	✓	✓	✓
	Mexico	✓		✓
	USA	✓		✓
Asia	China	✓	✓	✓
	India	✓		✓
	Japan (NOK)	✓		✓

# The right oil for your application

Gears play a vital role in all areas of the textile industry. To make production as efficient as possible, make sure you select the right gear oil for your application. You will find other useful advice below. For special applications, however, e.g. where very long service intervals are to be expected, or where operating conditions are very special, you should consult the experts from Klüber Lubrication. They will help you utilise all of your application's potential by using the ideal lubricant. For selecting the right oil for your gears, parameters such as performance, speeds, environmental influences and special operating conditions need to be taken into consideration. Based on this information, it is possible to select the

- oil type
- wear protection
- viscosity

which enables the gear oil to optimally perform its tasks, which include:

- absorbing forces
- reducing friction
- minimising wear
- dissipating heat
- absorbing wear and contamination

## Requirements to be met by gear oils

Gear oil properties are determined by the base oil and the additives. The essential requirements for gear oils are described by leading gear manufacturers in international standards and specifications. They include:

- operating temperature range
- viscosity
- ageing behaviour
- low-temperature behaviour
- corrosion protection on steel/nonferrous metal
- foam behaviour
- elastomer compatibility
- compatibility with interior coatings
- wear protection – fretting, micropitting

The more we know about your application, the better we can determine which lubricant is the optimum choice in your case. If you have any further questions, please do not hesitate to contact our specialists.



## Elastomer compatibility of gear oils

In the textile industry, compatibility of the gear oils with elastomer is crucial. The materials used for radial shaft seals (RSS) or static seals, e.g. O-ring seals, must not become brittle or softer when exposed to gear oil as their sealing capacity will be affected. The seals would suffer premature wear, leading to leakage. Cleaning and possibly expensive gear repairs will then be necessary.

Compatibility with the seals should be considered especially when higher torques lead to higher operating temperatures, or when a gearbox is changed from mineral to synthetic oil lubrication. The tests used for verifying the static and dynamic compatibility of gear oils with elastomers are based on ISO 1817 and DIN 3761, respectively.

Through the Lube & Seal programme jointly run by Klüber Lubrication and Freudenberg Sealing and Vibration Control Technology, gear oils made by Klüber Lubrication are now designed to match radial shaft seals made by Freudenberg. So now gear oils from Klüber Lubrication can be selected to ensure trouble-free operation. If the materials to be used are selected carefully, run-times of more than 20,000 hours can be attained. If you have any further questions, please do not hesitate to contact our specialists.

## General overview of the compatibility of gear oils with sealing materials

	<b>Abbreviation</b>	NBR	ACM	VQM	FKM	PTFE
	<b>Type</b>	Acrylonitrile butadiene rubber	Acrylate rubber	Silicone rubber	Fluorinated rubber, e.g. Viton	Polytetra-fluoroethylen
	<b>Thermal resistance</b>	up to 100 °C	up to 125 °C	up to 125 °C	up to 150 °C	up to 150 °C
Klüberoil GEM 1 N	Mineral oil	●	●	■	■	■
Klübersynth GEM 4 N	Polyalphaolefin	●	●	■	●	●
Klübersynth GH 6 Klübersynth UH1 6	Polyglycol	●	x	■	■	●

● compatible   ■ compatible under certain conditions   ■ Mineral oils are only compatible with seals up to 125 °C  
 ■ compatible with all gear oils, but air shedding may be impaired   x not compatible

# Oil change: how it's done

## Normal oil change without changeover

Oil-lubricated gears require an oil change from time to time since the oil changes its characteristics beyond limits due to the operating and ambient conditions, e.g. ageing, abrasion and contamination. The objective of the oil change is to ensure continued reliable lubrication. This is also the objective when replacing a gear oil that is basically still fit to use, but not under the prevailing operating conditions.

When an oil change of this type is performed, some residual amount of old oil will always remain in the gearbox. In many cases, these residues cannot be tolerated and some way of removing them must be found. The simplest method is flushing the gears. If possible, the old gear oil is drained while still warm, i.e. immediately after the gears are stopped. With the subsequent flushing procedures, further residues are removed. The oil container and inside walls of the gearbox can also be cleaned using a non-fraying cloth (do not use cleaning wool) and a rubber blade.

Profound contamination in the form of deposits caused by strongly aged oil pose a major challenge. In such cases, cleaning oil must be used, and all accessible parts of the gearbox cleaned manually. A suitable oil for cleaning gears is KlüberSummit Varnasolv, which quickly dissolves residues when added to mineral oil or PAO when added at a concentration of 10 %. At first, approx. 10 % of the gear oil is drained, and then the same quantity of KlüberSummit Varnasolv is added. After 24 to 48 hours of operation, the oil can be drained. Any remaining residues can be removed mechanically.

## Oil change checklist – Gear inspection

Clean gears
Drain oil while warm
Inspect teeth
Replace filters
Fill in new oil
Put gear into operation and stop again
Check oil level
Take reference oil sample, if required



### Contaminated gears

- Drain oil while warm
- Fill flushing oil
- Operate gear for approx. 30 to 60 min without load or injection system only
- Drain flushing oil
- Inspect teeth
- Replace filters
- Fill in new oil
- Put gear into operation and stop again
- Check oil level
- Take reference oil sample, if required

### Strongly contaminated gears

- Drain approx. 10 % of the oil fill while warm
- Top up with Varnasolv
- Operate gears for 24 to 48 hours
- Drain oil while warm
- Fill flushing oil\*
- Operate gear for approx. 30 to 60 min without load or injection system only\*
- Drain flushing oil\*
- Inspect teeth
- Replace filters
- Fill in new oil
- Put gear into operation and stop again
- Check oil level
- Take reference oil sample, if required

\* if required

# The rolling bearing

## One of the most important machine elements in the textile industry

They may be designed as ball or roller bearings, radial or thrust bearings: what they all have in common is the transmission of load and power via rolling elements located between bearing rings. This is a simple and successful principle, at least as long as the contact surfaces remain separated. However, if the surfaces come into contact with one another, there can be trouble ahead: the resulting damage caused may be anything from light, hardly perceptible surface roughening, pronounced sliding and scratching marks, to extensive material transfer that may promote premature bearing failure – with expensive consequences! A vital requirement for low-wear or even wear-free operation of rolling bearings is the sustained separation of the surfaces of rolling elements and raceways, i.e. the friction bodies, by means of a suitable lubricant. Ideally, it should wet all the surfaces in the bearing.

### Speciality lubricant – an essential design element

The experts at Klüber Lubrication know from 90 years of experience in the manufacture of speciality lubricants that a rolling bearing can only be as good as the lubricant it contains. We consider lubricants to be vital design elements that require constant improvement as the operating conditions under which bearings must perform become tougher and tougher. While a few years ago, for example, 60,000 operating hours was considered a good operational lifetime for bearings in a fan motor, today 110,000 operating hours or more are expected.

### Grease application in rolling bearings

Around 90 % of all rolling bearings are lubricated with grease. Grease lubrication presents far fewer sealing problems than oil lubrication and allows much simpler machine designs. With grease-lubricated rolling bearings we differentiate between lifetime lubrication and bearings which require relubrication. In general terms lifetime lubrication does not depend on the bearing but on the requirements of the particular application.

### Relubrication – compatibility of greases

The issue is whether the new grease really is compatible with the old one. Compatibility should be checked with great care. If the two greases are incompatible, liquefaction, overheating or bearing damage can be the consequence. For detailed information on the miscibility of base oils and thickeners, please refer to the tables below. If you have any further questions, please do not hesitate to contact our specialists.

### The right amount of grease in the bearing

The correct quantity of grease will vary based on the bearing type and bearing rotational speed. It is therefore important to determine the precise grease quantity for the bearings prior to changeover. Purging of a bearing with fresh grease will involve completely filling the bearing with grease. This method may prove unsuitable, for instance, when considering high-speed bearings which require an extremely low percentage of grease fill. If you have any further questions, please do not hesitate to contact our specialists.



## Miscibility of base oils

	Mineral oil	Synth. hydrocarbon	Esteroil	Polyglycol	Silicone oil (methyl)	Perfluoroalkylether	Silicone oil (phenyl)	Polyphenylether oil
<b>Mineral oil</b>	+	+	+	-	-	-	+/-	+
<b>Synth. hydrocarbon</b>	+	+	+	-	-	-	-	+
<b>Ester oil</b>	+	+	+	+	-	-	+	+
<b>Polyglycol</b>	-	-	+	+	-	-	-	-
<b>Silicone oil (methyl)</b>	-	-	-	-	+	-	+/-	-
<b>Perfluoroalkylether</b>	-	-	-	-	-	+	-	-
<b>Silicone oil (phenyl)</b>	+/-	-	+	-	+/-	-	+	+
<b>Polyphenylether oil</b>	+	+	+	-	-	-	+	+



+ miscible      +/- partially miscible      - not miscible

## Miscibility of thickeners\*

		Metal soaps				Complex soaps					Other thickeners		
		Al	Ca	Li	Na	Al	Ba	Ca	Li	Na	Bentonite	Polyurea	PTFE
Metal soaps	<b>Al</b>	+	+/-	+	+/-	+	+/-	+	+	+/-	+	+	+
	<b>Ca</b>	+/-	+	+	+	+	+	+	+/-	+	+	+	+
	<b>Li</b>	+	+	+	-	+	+	+	+	-	+/-	+/-	+
	<b>Na</b>	+/-	+	-	+	+	+	+/-	+/-	+	-	+	+
Complex soaps	<b>Al</b>	+	+	+	+	+	+	+/-	+	+/-	+/-	+/-	+
	<b>Ba</b>	+/-	+	+	+	+	+	+/-	+/-	+	+	+/-	+
	<b>Ca</b>	+	+	+	+/-	+/-	+/-	+	+	+	+/-	+	+
	<b>Li</b>	+	+/-	+	+/-	+	+/-	+	+	+/-	+	+/-	+
	<b>Na</b>	+/-	+	-	+	+/-	+	+	+/-	+	-	+	+
Other thickeners	<b>Bentonite</b>	+	+	+/-	-	+/-	+	+/-	+	-	+	+	+
	<b>Polyurea</b>	+	+	+/-	+	+/-	+/-	+	+/-	+	+	+	+
	<b>PTFE</b>	++	+	+	+	+	+	+	+	+	+	+	+

+ miscible      +/- partially miscible      - not miscible  
 \* Base oils must be miscible

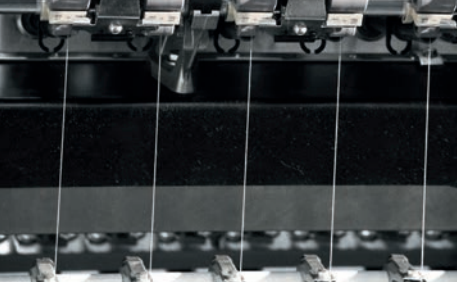



# Lubricants for spinning machines

Application	Machine/Component	Speciality lubricant from Klüber Lubrication
	Rotary plate (plain bearings) in carders and drawing frames	Klüberpaste 46 MR 401 ALTEMP Q NB 50
	Bearings of top and bottom rollers in the drawing system of drawing frames	ISOFLEX TOPAS NB 52  ISOFLEX LDS 18 Special A ISOFLEX Topas NB 52
	Bearings of top and bottom rollers in the drawing system of ring spinning frames	STABURAGS NBU 12 / 300 KP  STABURAGS NBU 12 / 300 KP
	Open-ended (OE) spinning turbines (direct drive/TwinDisc drive)	ISOFLEX NBU 15  ISOFLEX NCA 15  ISOFLEX LDS 18 Special A  ISOFLEX PDP 65
	Opening rollers (OE spinning frame)	ISOFLEX NBU 15



Advantages and application notes	Your benefits	Notes
<ul style="list-style-type: none"> <li>- Excellent resistance to media and excellent corrosion protection</li> <li>- Also available as easy-to-use spray</li> <li>- Good load-carrying capacity</li> </ul>	<ul style="list-style-type: none"> <li>- Lower maintenance costs</li> <li>- Lower risk of contamination of the spinning material in the can</li> </ul>	<p>Klüberpaste 46 MR 401 and ALTEMP Q NB 50 should be in every workshop. The assembly pastes protect against fretting corrosion for a long time even under adverse operating conditions.</p>
<ul style="list-style-type: none"> <li>- Relubrication intervals may exceed by far the specified intervals</li> </ul>	<ul style="list-style-type: none"> <li>- Reduction of downtime</li> <li>- Lower maintenance costs</li> <li>- Lower contamination risk</li> </ul>	<p>The lubricant to be selected depends on the recommendation of the machine manufacturer. Vouk recommends ISOFLEX TOPAS NB 52.</p> <p>Rieter, Ingolstadt / Germany uses ISOFLEX LDS 18 Special A for first fill and lists the product in the lubricant chart.</p> <p>Enables product streamlining and reduces the risk of lubricant mix-up M.</p>
<ul style="list-style-type: none"> <li>- Excellent corrosion protection and long-term lubrication of bottom roller bearings</li> <li>- Depending on the operating conditions, relubrication intervals of the upper roller bearings can be 30,000 to 50,000 operating hours, or up to 3,000 hours for the bottom rollers</li> </ul>	<ul style="list-style-type: none"> <li>- Increased operational reliability and reduction of downtime</li> <li>- Lower maintenance costs</li> <li>- Reduces leakage and contamination</li> </ul>	<p>STABURAGS NBU 12 / 300 KP has been used for initial lubrication by e.g. Texparts and Spindelfabrik SUESSEN for many years.</p>
<ul style="list-style-type: none"> <li>- For extremely high speeds</li> <li>- Reduces temperature rise and wear on bearings</li> <li>- Extends relubrication intervals</li> </ul>	<ul style="list-style-type: none"> <li>- Increased operational reliability, extended service life of bearings and much longer service intervals</li> </ul>	<p>The lubricant to be selected depends on the recommendation of the machine manufacturers.</p> <p>ISOFLEX PDP 65 is used for the depot and relubrication of Rieter OE spinning machines with TwinDisc drive.</p>
<ul style="list-style-type: none"> <li>- Smooth running of bearings and uniform opening of the sliver</li> </ul>	<ul style="list-style-type: none"> <li>- Higher operational safety and reduced downtime</li> </ul>	

# Lubricants for synthetic fibre spinning machines

Application	Machine/Component	Speciality lubricant from Klüber Lubrication
	Spinning pumps	UNISILKON TK 017 THERM series
	Screwed connections of spinerets	Klüberpaste UH1 96-402
	Surfaces of spinerets	Klüberpaste HEL 46-450 UNISILKON M 2000 Spray
	Godet bearings	UNISILKON L 50/2  BARRIERTA L 55/2 Klübertemp GR AR 555  PETAMO GHY 441 Klübersynth HB 74-401



Advantages and application notes	Your benefits	Notes
<ul style="list-style-type: none"> <li>– Reliable start-up of precision gear pumps in the melt spinning process. Prevention of wear due to insufficient lubrication during start-up</li> </ul>	<ul style="list-style-type: none"> <li>– Longer life of gearwheels</li> </ul>	<p>UNISILKON TK 017 THERM oils are recommended by pump manufacturers and successfully used by synthetic fibre processors.</p>
<ul style="list-style-type: none"> <li>– White assembly paste</li> </ul>	<ul style="list-style-type: none"> <li>– Much less time required for changing the spinnerets</li> </ul>	<p>Klüberpaste UH1 96-402 and Klüberpaste HEL 46-450 can be used up to 200 °C.</p>
<ul style="list-style-type: none"> <li>– Black assembly paste</li> </ul>		
<ul style="list-style-type: none"> <li>– Prevents clogging of the spinnerets at temperatures up to 200 °C</li> </ul>	<ul style="list-style-type: none"> <li>– Reliable start-up of production and prevention</li> <li>– Normally no additional cleaning required</li> </ul>	<p>UNISILKON M 2000 Spray is a universal separating agent and lubricant for thermo- and duroplastics as well as elastomers and can also be used as sliding agent for seals.</p>
<ul style="list-style-type: none"> <li>– Long-term lubrication and longer service life of bearings under demanding conditions</li> </ul>	<ul style="list-style-type: none"> <li>– Higher operational safety and reduced downtime</li> <li>– Reduces maintenance costs</li> <li>– Reduces leakage and contamination</li> </ul>	<p>The lubricant selection is based on the recommendations provided by the manufacturers of the installations, e.g. Starlinger:  up to 150 °C PETAMO GHY 441;  150 to 170 °C BARRIERTA L 55/2</p> <p>or Barmag:  up to 200 °C UNISILKON L 50/2</p>



# Lubricants for synthetic fibre processing machines

Application	Machine/Component	Speciality lubricant from Klüber Lubrication
	Cold and hot separator rollers	ISOFLEX SUPER LDS 18/25 S
	Spinning rings	SYNTHESO XOL 12  Klüberoil Tex 1-22 N
	Bearings of filament coiling after drawing	ISOFLEX NBU 15

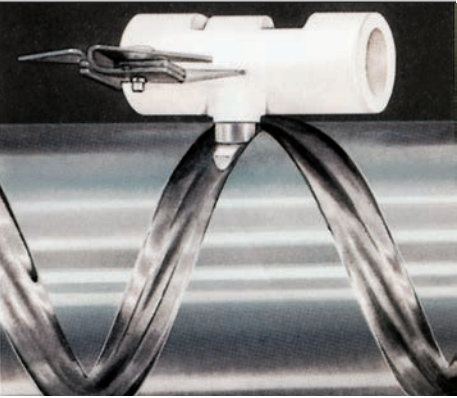
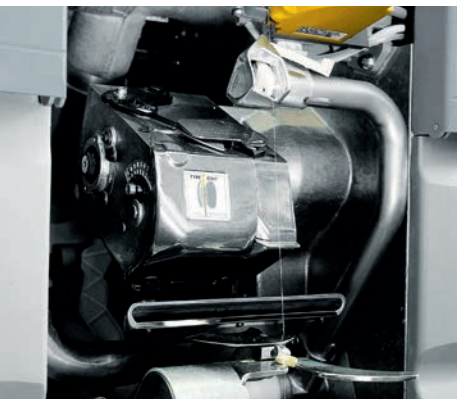

Advantages and application notes	Your benefits	Notes
<ul style="list-style-type: none"> <li>- Smooth running of cold and hot separator rollers</li> <li>- Minimal maintenance required for many years</li> <li>- Prevents thread breakage</li> </ul>	<ul style="list-style-type: none"> <li>- Prevents production downtime</li> <li>- Reduced maintenance costs</li> </ul>	<p>ISOFLEX SUPER LDS 18/25 S is a long-term speciality lubricant (dispersion) free of CFC. Please observe the solvent's extended evaporation period during relubrication.</p>
<ul style="list-style-type: none"> <li>- Synthetic oil with good wetting properties and low ageing tendency</li> <li>- Prevents contact of the friction components and significantly reduces wear</li> </ul>	<ul style="list-style-type: none"> <li>- Longer component life</li> <li>- Reduced downtime</li> </ul>	
<ul style="list-style-type: none"> <li>- Mineral-oil based, fully scourable and biodegradable oil with good wetting properties</li> </ul>		
<ul style="list-style-type: none"> <li>- High-speed grease with good wetting properties</li> <li>- Reduces bearing loads and wear</li> <li>- Ensures accurate coiling of the filament</li> </ul>	<ul style="list-style-type: none"> <li>- Reduced downtime owing to lower bearing wear despite very high speeds</li> </ul>	

# Lubricants for twisting and spool winding machines

Application	Machine/Component	Speciality lubricant from Klüber Lubrication
	Thread guide slide and zigzag winding guide	ISOFLEX TEL 3000 ALTEMP Klübersynth LI 44-22
	Travelling knotter and travelling splicer	MOLYBKOMBIN M 5-Spray  QUIETSCH-EX Spray CONTRACOR Fluid H1 Spray
	Spindle can bearing and belt guide rollers	ISOFLEX LDS 18 SPECIAL A ISOFLEX NBU 15 ISOFLEX TOPAS L 32N





Advantages and application notes	Your benefits	Notes
<ul style="list-style-type: none"> <li>- Dynamically very light lubricating greases offering emergency lubricating properties due to solid lubricants</li> <li>- Light-coloured solid lubricants ensure emergency lubricating properties and light colour of lubricant</li> <li>- Reduce bearing temperature</li> </ul>	<ul style="list-style-type: none"> <li>- Longer maintenance intervals as the temperature of the friction points is reduced owing to the good wear protection of the lubricant</li> <li>- Minimum lubricant quantities required due to the good lubricating performance, hence lower contamination risk</li> </ul>	
<ul style="list-style-type: none"> <li>- Emergency lubricating properties due to solid lubricants</li> <li>- Spray allows easy lubrication of friction points difficult to access</li> </ul>	<ul style="list-style-type: none"> <li>- Reduced maintenance and downtime</li> </ul>	<p>Approved for the lubrication of the internal mechanisms in the housing and the gear reducer. Can also be used for the internal parts of the winding machines and for the gear teeth in the reduction gear of the travelling knotter and splicer.</p>
<ul style="list-style-type: none"> <li>- Thin lubricating oil with good wetting properties on metal surfaces, good corrosion protection and rust-dissolving capacity</li> <li>- Spray allows easy lubrication of friction points difficult to access</li> </ul>		<p>Only requires a very thin layer to be efficient.</p>
<ul style="list-style-type: none"> <li>- Dynamically light, synthetic lubricating greases for long-term lubrication at high speeds</li> <li>- Depending on the operating conditions, relubrication intervals of 5,000 and 10,000 operating hours are possible</li> <li>- Reduce wear and temperature rise of bearings and rollers. Power requirement is reduced and the service life of components is extended</li> <li>- Allow smooth running of gears</li> </ul>	<ul style="list-style-type: none"> <li>- Lower energy consumption</li> <li>- Longer relubrication intervals, hence reduced downtime</li> </ul>	<p>The lubricant to be selected depends on the recommendations of the machine manufacturer.</p>

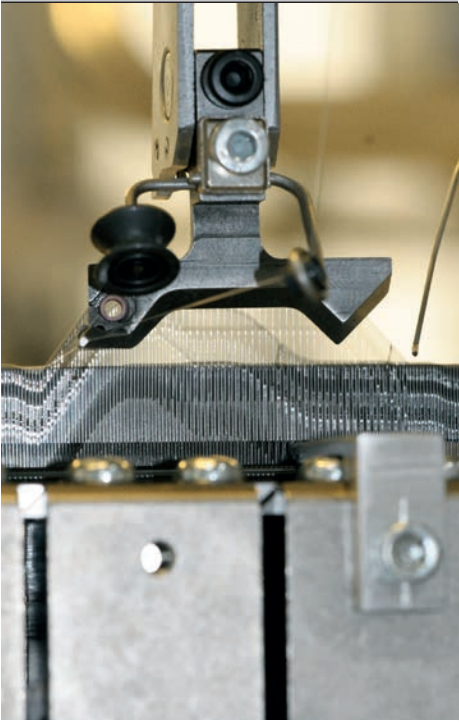
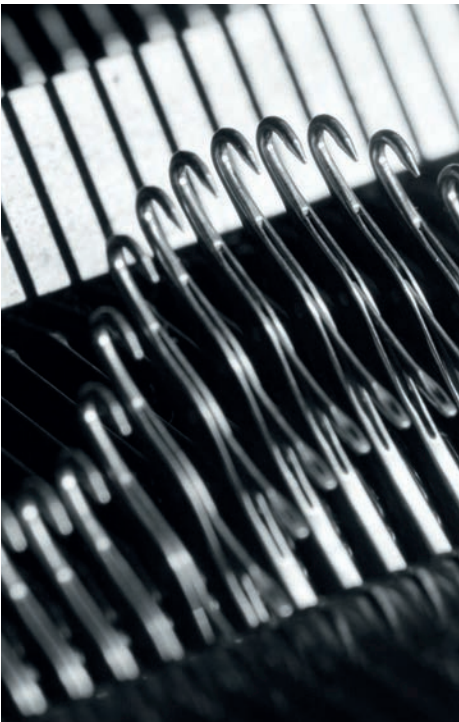

# Lubricants for knitting machines

Application	Machine/Component	Speciality lubricant from Klüber Lubrication
	<p>For needles and sinkers in circular knitting machines</p>	<p>Running-in oil: Klüber Silvertex P 91</p> <hr/> <p>Needle oil: Klüberoil TEX 1-22 N/1-32 N Klüber Silvertex W 22/W 32 Klüber Silvertex T 22/T 32 Klüber Madol 900 N series</p> <hr/> <p>Cleaning oil: Klüber Silvertex R 14</p>
	<p>For flat-bed knitting machines (stitch-forming elements)</p>	<p>Running-in oil: Klüber Silvertex P 91</p> <hr/> <p>Needle oil: Klüber Silvertex T 32/T 46 Klüber Madol 172 Supreme Klüber Madol 183 Supreme</p> <hr/> <p>Cleaning oil: Klüber Silvertex R 14</p>



Advantages and application notes	Your benefits	Notes
<ul style="list-style-type: none"> <li>- Fully synthetic running-in oil which quickly removes wear particles, thus ensuring accurate running-in of friction points</li> </ul>	<ul style="list-style-type: none"> <li>- Long service life of the stitch-forming elements, hence higher operational safety and minimum maintenance</li> </ul>	<p>The lubricant to be selected depends on the recommendations of the machine manufacturer and the operating conditions. We will be pleased to provide comprehensive consulting.</p>
<ul style="list-style-type: none"> <li>- All these needle oils comply with the legal requirements set forth in the EU Directive 2003/53/EG for placing NP/NPE-containing products on the market</li> <li>- Partially synthetic needle and sinker oils with good load-carrying capacity and good wear protection</li> <li>- The needle oil series Klüberoil TEX 1-... N, Klüber Silvertex W and Klüber Silvertex T are biodegradable acc. to OECD-301c</li> </ul>		
<ul style="list-style-type: none"> <li>- Removes clogging and contamination of the stitch-forming elements</li> </ul>		
<ul style="list-style-type: none"> <li>- Fully synthetic running-in oil which quickly removes wear particles, thus ensuring accurate running-in of friction points</li> </ul>	<ul style="list-style-type: none"> <li>- Long service life of the stitch-forming elements, hence higher operational safety and minimum maintenance</li> </ul>	<p>The viscosity to be selected depends on the recommendation of the machine manufacturer and the operating conditions.</p>
<ul style="list-style-type: none"> <li>- Klüber Silvertex T 32/T 46: Partially synthetic needle and sinker oil with good load-carrying capacity and good wear protection</li> <li>- Complies with the legal requirements set forth in EU Directive 2003/53/EC for placing NP/NPE-containing products on the market</li> <li>- Biodegradable acc. to OECD-301c</li> </ul>		
<ul style="list-style-type: none"> <li>- Removes clogging and contamination of the stitch-forming elements</li> </ul>		

# Lubricants for knitting machines

Application	Machine/Component	Speciality lubricant from Klüber Lubrication
	Slide rails on flat-bed knitting machines	ISOFLEX TEL 3000 ALTEMP
	Hosiery knitting machines (stitch-forming elements, gears and bearings)	Running-in oil: Klüber Silvertex P 91  Needle oil: Klüber Madol 162 Supreme Klüber Madol 172 Supreme Klüber Madol 183 Supreme  Cleaning oil: Klüber Silvertex R 14



Advantages and application notes	Your benefits	Notes
<ul style="list-style-type: none"> <li>- Reduces wear and increases smooth running of impulse transmitter rail, carriage guide and racking unit</li> </ul>	<ul style="list-style-type: none"> <li>- Reduced maintenance requirement</li> <li>- Higher operational safety</li> </ul>	<p>The lubricant to be selected depends on the recommendations of the machine manufacturer and the operating conditions. We will be pleased to provide comprehensive consulting.</p>
<ul style="list-style-type: none"> <li>- Fully synthetic running-in oil which quickly removes wear particles, thus ensuring accurate running-in of friction points</li> </ul>	<ul style="list-style-type: none"> <li>- Long service life of the stitch-forming elements, hence higher operational safety and minimum maintenance</li> </ul>	
<ul style="list-style-type: none"> <li>- All these needle oils comply with the legal requirements set forth in EU Directive 2003/53/EC for placing NP/NPE-containing products on the market</li> <li>- Needle and sinker oils with good load-carrying capacity and good wear protection</li> </ul>		<p>The viscosity to be selected depends on the recommendations of the machine manufacturer and the operating conditions. Messrs. Lonati uses Klüber Madol 183 Supreme for the initial equipment and exclusively recommends this oil for relubrication.</p>
<ul style="list-style-type: none"> <li>- Removes clogging and contamination of the stitch-forming elements</li> </ul>		<p>For machines with oil circulation lubrication we recommend using the cleaning oil Klüber Silvertex R 14 before changing the oil.</p>

# Lubricants for warp knitting machines

Application	Machine/Component	Speciality lubricant from Klüber Lubrication
	Guide bars in warp beams of knitting machines	QUIETSCH-EX Spray  ALTEMP Q NB 50  Klüberpaste 46 MR 401
	Needle bars/guide bars	MICROLUBE GL 261



Advantages and application notes	Your benefits	Notes
<ul style="list-style-type: none"> <li>- For the lubrication of flat-bed frames</li> <li>- Good wetting of friction points</li> <li>- Stays at the friction point for a long time</li> <li>- Can also be used as anti-rust agent</li> </ul>	<ul style="list-style-type: none"> <li>- Reduced maintenance and downtime</li> </ul>	
<ul style="list-style-type: none"> <li>- For the lubrication of the ball bushings</li> <li>- Very good media resistance and wear protection</li> <li>- Also available as easy-to-use spray</li> </ul>		<p>Klüberpaste 46 MR 401 and ALTEMP Q NB 50 should be in every workshop. The assembly pastes protect against fretting corrosion for a long time even under adverse operating conditions.</p>
<ul style="list-style-type: none"> <li>- For the lubrication of ball bushings</li> <li>- Good load-carrying capacity and wear protection</li> </ul>		
<ul style="list-style-type: none"> <li>- Good lubricating capacity in the boundary friction regime</li> <li>- Longer component life due to a special combination of active agents when exposed to vibrations</li> </ul>	<ul style="list-style-type: none"> <li>- Less maintenance and machine downtime</li> </ul>	<p>MICROLUBE GL 261 is recommended by Messrs. Karl Mayer, Obertshausen/Germany.</p>

# Lubricants for weaving machines

Application	Machine/Component	Speciality lubricant from Klüber Lubrication
	Weaving machine gears	Klübersynth 100 KV Klübersynth 80 KV Klübersynth 50 KV Klübersynth G4-130
	Gear of the jacquard machine	Klübersynth G4-150
	Gripper looms	MICROLUBE GBU Y 131
		STABURAGS NBU 12 ALTEMP
	Motor coupling with brake and sliding block	ISOFLEX TOPAS NB 52 ISOFLEX ALLTIME SL 2
	Rapier guide roller	
	Distributor cutter	
	Open gears	GRAFLOSCON CA ULTRA Spray
Chains	HOTEMP 2000 Spray	







Advantages and application notes	Your benefits	Notes
<ul style="list-style-type: none"> <li>- Synthetic gear oils especially for weaving machines</li> <li>- Depending on the operating conditions, oil change intervals can be extended to approx. 5,000 to 20,000 operating hours compared to mineral-oil based gear oils due to their good ageing resistance</li> </ul>	<ul style="list-style-type: none"> <li>- Reduced maintenance costs and higher output due to longer oil change intervals</li> </ul>	<p>The lubricant to be selected depends on the recommendations of the machine manufacturer and on the machine type. Promatech approved:</p> <ul style="list-style-type: none"> <li>- type VAMATEX without cooler: Klübersynth 100 KV</li> <li>- with loom cooler: Klübersynth 50 KV</li> <li>- type SOMET: Klübersynth G 4-130 (for relubrication)</li> <li>- type R9500: Klübersynth 80 KV</li> </ul>
<ul style="list-style-type: none"> <li>- Good wetting of the friction point The uniform lubricating film is not affected by demanding operating conditions, e.g. vibrations</li> <li>- Compatible with plastics and elastomers</li> <li>- Low copper corrosion</li> </ul>	<ul style="list-style-type: none"> <li>- Tried-and-tested material compatibility to protect the sensitive machine components for a long time</li> </ul>	<p>The product is approved by Stäubli</p>
<ul style="list-style-type: none"> <li>- Allows extension of relubrication intervals to one month, even at extremely high speeds</li> <li>- Shows a very good backflow behaviour, which is especially important in friction points subject to oscillating motion</li> </ul>	<ul style="list-style-type: none"> <li>- Longer service life of the bearings in the flywheel support and the crosshead axle, also when subjected to strong vibrations</li> <li>- Increased output and reduced maintenance</li> </ul>	<p>The lubricant is recommended by Sultex (Sulzer Textil).</p>
<ul style="list-style-type: none"> <li>- Reliable protection against tribo-corrosion</li> </ul>		
<ul style="list-style-type: none"> <li>- Improves smooth operation of friction points for a long time</li> </ul>	<ul style="list-style-type: none"> <li>- Reduced maintenance</li> </ul>	<p>The lubricant to be selected depends on the recommendations of the machine manufacturers and on the individual operating conditions. We will be pleased to advise you.</p>
<ul style="list-style-type: none"> <li>- Very good wear protection and adhesion ensure extremely long relubrication intervals</li> <li>- Easy application by spray</li> </ul>	<ul style="list-style-type: none"> <li>- Minimum-quantity lubrication possible, long relubrication intervals and hence reduced maintenance</li> </ul>	
<ul style="list-style-type: none"> <li>- Universal spray for chains – also for high-speed transmission, control and conveyor chains</li> <li>- Good adhesion and wear protection</li> <li>- Easy application by spray</li> </ul>		

# Lubricants for textile finishing machines

Application	Machine/Component	Speciality lubricant from Klüber Lubrication
	Rolling bearings in washing and mercerising machines, dyeing machines and festoon steamers	STABURAGS NBU 12 STABURAGS NBU 12/300 KP  Klüberplex BE 31-222 Klüberplex BE 31-502
	Corrosion protection for the inner lining of steamers	STABURAGS NBU 30  Klüberplex BE 31-502
	Chains in steamers	Klübersynth CTH 2-260  PRIMIUM FLUID SPECIAL  HOTEMP 2000 Spray
	Bearings in steamers	BARRIERTA L 55/2 Klübertemp GR AR 555

Advantages and application notes	Your benefits	Notes
<ul style="list-style-type: none"> <li>- Special greases resistant to water and steam</li> <li>- Also resistant to aqueous alkaline and acid solutions</li> </ul>	<ul style="list-style-type: none"> <li>- High operational safety</li> <li>- Considerably reduced maintenance</li> </ul>	<p>The lubricant to be selected depends on the operating conditions. We will be pleased to provide comprehensive consulting.</p>
<ul style="list-style-type: none"> <li>- Very good corrosion protection of bearings due to the good sealing effect</li> </ul>	<ul style="list-style-type: none"> <li>- Economical long-term protection</li> <li>- Internal coating lasts for one year or more, in most cases: no premature, expensive replacement of the steamer lining</li> </ul>	<p>The lubricant to be selected depends on the recommendations of the machine manufacturers and on the individual operating conditions. We will be pleased to advise you.</p>
<ul style="list-style-type: none"> <li>- Klübersynth CTH 2-260 Supreme offers particularly high thermal stability</li> <li>- All these products are high-temperature chain oils for temperatures up to 250 °C</li> <li>- Good wetting properties</li> <li>- Low formation of residues</li> <li>- Good regenerating effect of the chain oil during relubrication</li> </ul>	<ul style="list-style-type: none"> <li>- Smooth operation and reduced repair costs</li> </ul>	<p>The lubricant to be selected depends on the recommendations of the machine manufacturers and on the individual operating conditions. We will be pleased to advise you.</p>
<ul style="list-style-type: none"> <li>- Fully synthetic, long-term and high-temperature bearing grease</li> <li>- Excellent resistance to aggressive chemicals and steam</li> </ul>	<ul style="list-style-type: none"> <li>- Smooth operation and reduced repair costs</li> </ul>	



# Lubricants for textile finishing machines

Application	Machine/Component	Speciality lubricant from Klüber Lubrication
	<p>Gaskets in dyeing equipment and yarn steamers</p>	<p>SYNTHESO PROBA 270</p>
	<p>Bearings of washing liquor circulation pump</p>	<p>STABURAGS NBU 12/300 KP</p> <p>PETAMO GHY 133 N Klübersynth HB 74-401</p>
	<p>Rolling and plain bearings in heated calenders</p>	<p>Klübersynth GH 6 series</p>



Advantages and application notes	Your benefits	Notes
<ul style="list-style-type: none"> <li>- Fully synthetic lubricating grease, compatible with natural and synthetic rubber</li> <li>- Prevents sticking of the seal, therefore the lids open and close more easily and the service life of seals is considerably extended</li> <li>- In most cases, seal lubrication is required once a week only</li> </ul>	<ul style="list-style-type: none"> <li>- Reduced spare parts costs</li> </ul>	<p>SYNTHESO PROBA 270 is also an ideal assembly aid for all rubber seals.</p>
<ul style="list-style-type: none"> <li>- Very media-resistant bearing grease which is not washed out in case of seal leakage</li> </ul>	<ul style="list-style-type: none"> <li>- High operational safety</li> <li>- Longer bearing life and reduced maintenance</li> </ul>	<p>STABURAGS NBU 12/300 KP is recommended by Thies.</p> <p>Then recommends PETAMO GHY 133 N.</p>
<ul style="list-style-type: none"> <li>- Fully synthetic high-temperature oils with good viscosity-temperature behaviour</li> <li>- Can be delivered through oil pumps and pipe systems, also at room temperature</li> <li>- At high temperatures up to 150 °C or short peaks up to 180 °C (maximum film temperature 225 °C), Klübersynth GH 6 oils have a higher operational viscosity than mineral oils of the same ISO VG viscosity grade and fulfil the demands for the required full fluid-film lubrication</li> </ul>	<ul style="list-style-type: none"> <li>- Longer oil change intervals: reduced maintenance costs and downtime</li> </ul>	<p>Klübersynth GH 6 oils are available in all common ISO VG viscosity grades and hence comply with the manufacturers' specifications.</p>

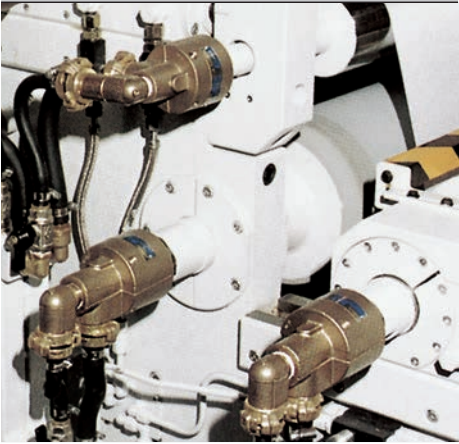

# Lubricants for textile finishing machines

Application	Machine/Component	Speciality lubricant from Klüber Lubrication
	Steam headers/rotary couplings in e.g. steam-heated finishing machines	PETAMO GY 193   BARRIERTA L 55/2   Klübertemp GR AR 555 Klübertemp HM 83-402
	Compensator and rollers in the hotflue	BARRIERTA L 55/2     Klübertemp GR AR 555 Klübertemp HM 83-402



Advantages and application notes	Your benefits	Notes
<ul style="list-style-type: none"> <li>- For temperatures up to 180 °C</li> </ul>	<ul style="list-style-type: none"> <li>- Reduced maintenance costs and downtime due to the good thermal stability, sealing effect and resistance to media</li> </ul>	<p>The product is recommended by Messrs. Meier, Heidenheim/Germany.</p>
<ul style="list-style-type: none"> <li>- For temperatures up to 260 °C</li> </ul>		
<ul style="list-style-type: none"> <li>- For temperatures up to 250 °C</li> </ul>		<p>The lubricant to be selected depends on the recommendations of the machine manufacturers and on the individual operating conditions. We will be pleased to advise you. BARRIERTA L 55/2 and Klübertemp HM 83-402 are recommended by Messrs. Meier, Heidenheim/Germany.</p>
<ul style="list-style-type: none"> <li>- Fully synthetic high-temperature bearing grease with long-term stability</li> <li>- For temperatures up to 260 °C</li> <li>- Very resistant to aggressive chemicals and vapours</li> </ul>	<ul style="list-style-type: none"> <li>- Considerably reduced maintenance due to long relubrication intervals</li> </ul>	<p>The lubricant to be selected depends on the recommendations of the machine manufacturers and on the individual operating conditions. We will be pleased to advise you.</p>
<ul style="list-style-type: none"> <li>- Fully synthetic high-temperature bearing grease with long-term stability</li> <li>- For temperatures up to 250 °C</li> <li>- Very resistant to aggressive chemicals and vapours</li> </ul>		

# Lubricants for stenter frames



Application	Machine/Component	Speciality lubricant from Klüber Lubrication
	Fabric conveyor chains: sliding chains	Klübersynth CTH 2-260 Supreme Klübersynth CTH 2-260  PRIMIUM FLUID SPECIAL
	Fabric conveyor chains: chains supported by ball bearings	BARRIERTA L 55/2 Klübertemp GR AR 555  Klübertemp HCB 83-402
	Fabric conveyor chains: needle bars and clips	UNISILKON M 2000 Spray  UNISILKON TK 002/100





Advantages and application notes	Your benefits	Notes
<ul style="list-style-type: none"> <li>- Klübersynth CTH 2-260 Supreme offers particularly high thermal stability</li> <li>- Separating effect on condensates and, consequently, less build-up of residues</li> <li>- Effective lubrication of the chain links and slide rails under varying operating conditions (speed, temperature, stretching tension)</li> <li>- Thermally stable up to 250 °C</li> <li>- Good evaporation behaviour</li> <li>- Regenerates pasty used oil, thus extending chain cleaning intervals</li> <li>- Good regenerative capacity, resulting in a significant extension of chain cleaning intervals</li> <li>- Good friction and wetting behaviour</li> <li>- Considerably improved viscosity-temperature behaviour compared with conventional chain oils</li> </ul>	<ul style="list-style-type: none"> <li>- Smooth operation and reduced repair costs</li> </ul>	<p>The lubricant to be selected depends on the recommendations of the machine manufacturer and the operating conditions. We will be pleased to provide comprehensive consulting.</p>
<ul style="list-style-type: none"> <li>- Fully synthetic, high-temperature and long-term bearing greases</li> <li>- For long-term lubrication or acc. to the recommendation of the manufacturer</li> <li>- Reduced relubrication quantity for long-term lubrication</li> </ul>	<ul style="list-style-type: none"> <li>- Smooth operation and reduced repair costs</li> </ul>	<p>The lubricant to be selected depends on the recommendations of the machine manufacturer and the operating conditions. We will be pleased to provide comprehensive consulting. BARRIERTA L 552 is recommended by MONFORTS.</p>
<ul style="list-style-type: none"> <li>- For easy manual application</li> </ul>	<ul style="list-style-type: none"> <li>- Reduced malfunctions in the production process</li> <li>- The lubricant impregnates the surface and forms a separating layer, thus facilitating residue removal</li> </ul>	<p>Regular application of the separating agent on the low-speed chain ensures optimum separating effect. Explicitly recommended by MONFORTS.</p>
<ul style="list-style-type: none"> <li>- For semi-automatic application via drip feed oilers or rotating brushes</li> </ul>		

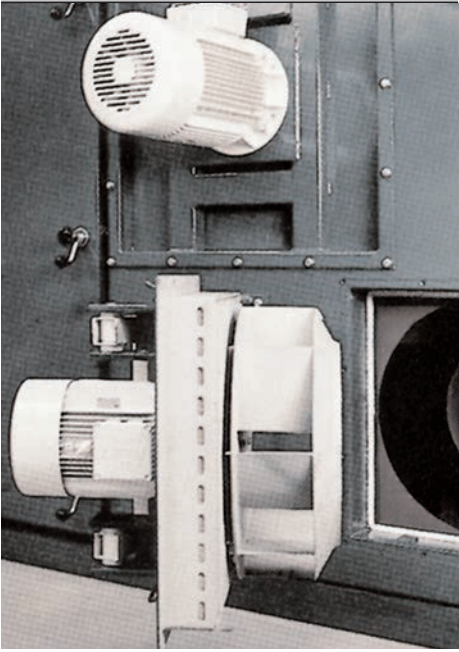

# Lubricants for stenter frames

Application	Machine/Component	Speciality lubricant from Klüber Lubrication
	Rolling bearings of electric motors, fans and exhaust fans in drawing frames	PETAMO GY 193  BARRIERTA L 55/2  Klübertemp GR AR 555
	Width adjustment spindles  Gears of the width adjustment spindle	MOLYBKOMBIN UMF T 4 Spray  STRUCTOVIS BHD MF



Advantages and application notes	Your benefits	Notes
<ul style="list-style-type: none"> <li>- Fully synthetic high-temperature bearing grease for temperatures up to 180 °C</li> <li>- Long relubrication intervals</li> </ul>	<ul style="list-style-type: none"> <li>- Reduced maintenance due to long relubrication intervals and lower cleaning requirements</li> <li>- Higher operational safety due to reduced bearing wear</li> </ul>	
<ul style="list-style-type: none"> <li>- Fully synthetic high-temperature long-term bearing grease for temperatures up to 260 °C</li> <li>- Long relubrication intervals</li> </ul>		
<ul style="list-style-type: none"> <li>- Fully synthetic high-temperature long-term bearing grease for temperatures up to 250 °C</li> <li>- Long relubrication intervals</li> </ul>		
<ul style="list-style-type: none"> <li>- Molybdenum disulphide bonded coating providing a dry lubricating film up to 450 °C</li> <li>- Largely prevents sticking due to build-up of lint and contamination. Consequently, easy and accurate width adjustment is possible requiring comparatively little maintenance</li> </ul>	<ul style="list-style-type: none"> <li>- Ensures smooth width adjustment thus increasing process reliability</li> <li>- Reduced maintenance</li> </ul>	<p>MOLYBKOMBIN UMF T 4 Spray has also proven successful in workshops for the assembly of e.g. screw connections and bearing seats. Protects against seizure, especially at high temperatures.</p>
<ul style="list-style-type: none"> <li>- Particularly for non-oiltight worm gears</li> <li>- Compatible with standard oil sight glasses and paint coatings</li> </ul>	<ul style="list-style-type: none"> <li>- Reduced wear of gears, hence longer component life</li> </ul>	<p>STRUCTOVIS BHD MF is an intrinsically viscous long-term and high-temperature lubricant which contains solid lubricants and is particularly suitable for worm gear drives in width adjustment spindles.</p>

# Lubricants for gears and electric motors in textile plants

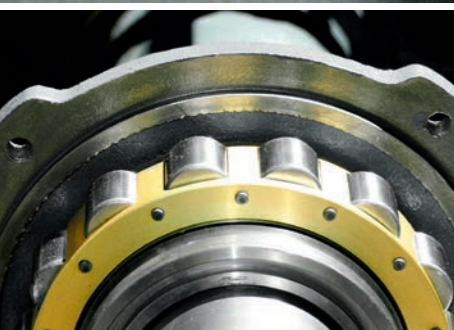
Application	Machine/Component	Speciality lubricant from Klüber Lubrication
	Spur and bevel gears	Klübersynth GEM 4 N series  Klübersynth GH 6 series
	Worm gears	Klübersynth GH 6 series  Klübersynth GEM 4 N series
	Rolling bearings in electric motors (can be relubricated)	PETAMO GHY 133 N  PETAMO GY 193
	Rolling bearings in electric motors (cannot be relubricated)	Klüberquiet BQH 72-102



Advantages and application notes	Your benefits	Notes
<ul style="list-style-type: none"> <li>- Miscible with mineral oil residues and largely compatible with paints and seals</li> <li>- Available in all common ISO VG grades</li> <li>- Offer good wear protection, also at extremely high tooth flank loads in the mixed friction regime (e.g. high torques and low speeds)</li> </ul>	<ul style="list-style-type: none"> <li>- Significantly longer oil change intervals as the oils' ageing process sets in later compared to mineral oil products, even at high temperatures</li> </ul>	<p>For special weaving machine gear oils, please see the chapter on weaving machines.</p>
<ul style="list-style-type: none"> <li>- Owing to the good friction behaviour the gear temperature and thus the ageing of the oil can be reduced</li> <li>- The oils offer good wear protection, also under high tooth flank loads in the mixed friction regime (e.g. high torques and low speeds)</li> </ul>		<p>Klübersynth GH 6 oils are not miscible with mineral oils or oils based on PAO. Compatibility with seal materials, paints and sight glasses has to be checked.</p>
<ul style="list-style-type: none"> <li>- Good friction behaviour. Reduce gear temperatures considerably and increase gear efficiency by more than 25 %</li> <li>- Owing to their special additives they reduce wear substantially, especially on materials that are typically used for worm gears</li> <li>- Depending on the operating conditions, oil change intervals are at least five times longer than those of mineral oils</li> </ul>	<ul style="list-style-type: none"> <li>- These oils offer a better thermal stability than mineral oil products; therefore ageing sets in later and oil change intervals are extended</li> <li>- These oils also reduce wear of gears and hence extend the service life of components</li> </ul>	<p>Klübersynth GH 6 oils are not miscible with mineral oils or oils based on PAO. Compatibility with seal materials, paints and sight glasses has to be checked.</p>
<ul style="list-style-type: none"> <li>- Klübersynth GEM 4...N oils are miscible with mineral oil residues and are largely compatible with paints and seals</li> </ul>		<p>Klübersynth GEM 4...N oils are available in all common ISO VG grades.</p>
<ul style="list-style-type: none"> <li>- For operating temperatures up to 160 °C</li> </ul>	<ul style="list-style-type: none"> <li>- Prevents premature bearing failure and machine downtime</li> </ul>	
<ul style="list-style-type: none"> <li>- For operating temperatures up to 180 °C</li> </ul>		
<ul style="list-style-type: none"> <li>- For lifetime lubrication</li> <li>- Very high resistance to temperature and speed</li> </ul>	<ul style="list-style-type: none"> <li>- Prevents premature bearing failure and machine downtime</li> </ul>	

# Lubricants and other products for compressors

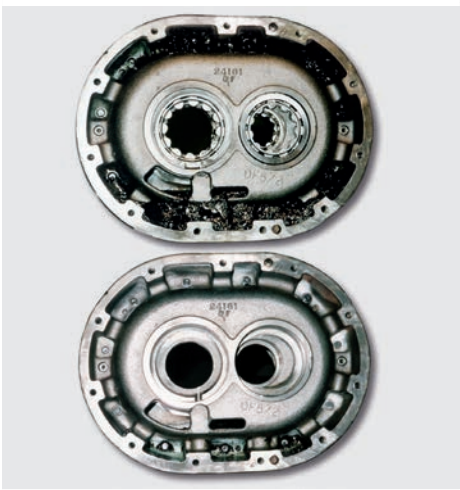
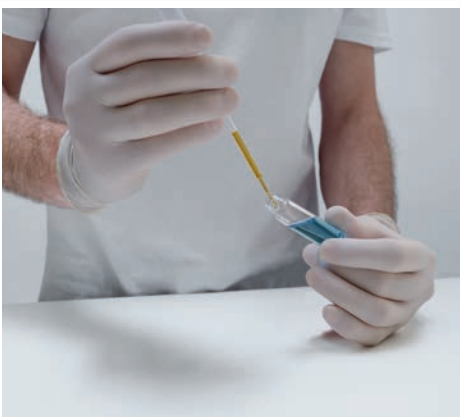
Application	Machine/Component	Speciality lubricant from Klüber Lubrication
	Screw-type compressor	<p>Klüber Summit SH series</p> <hr/> <p>Klüber Summit SB series</p> <hr/> <p>Klüber Summit PS series</p>
	Cleaning of rotary screw and rotary vane compressors	Klüber Summit Varnasolv
	Simple and quick method to analyse the compressor oil's condition in situ	Klüber Summit T.A.N-Kit



Advantages and application notes	Your benefits	Notes
<ul style="list-style-type: none"> <li>– Oil change intervals up to 10,000 hours</li> </ul>	<ul style="list-style-type: none"> <li>– Extends oil change intervals due to high oxidation stability</li> </ul>	<p>For normal operating conditions, i.e. discharge temperature max. 85 °C (176 °F), discharge pressure max. 8 bar, dry and clean intake air and oil circulation number &gt; 1.5.</p>
<ul style="list-style-type: none"> <li>– Oil change intervals up to 8,000 hours</li> </ul>		
<ul style="list-style-type: none"> <li>– Oil change intervals up to 5,000 hours</li> </ul>		
<ul style="list-style-type: none"> <li>– Effectively dissolves residues and contamination caused by mineral oil (e.g. carbon and oxidation residues) and removes them when changing the oil</li> </ul>	<ul style="list-style-type: none"> <li>– No downtime due to cleaning</li> <li>– Reduced costs due to easier cleaning process</li> <li>– Economical operation of the cleaned compressor</li> </ul>	<p>Cleaning fluid based on ester oil for screw-type, centrifugal and rotary vane compressors with oil circulation lubrication. Not miscible with oils based on polyglycol. Please see our product information leaflet for details on the cleaning process.</p>
<ul style="list-style-type: none"> <li>– Quick method to analyse the condition (neutralisation number) of the compressor oil in situ</li> <li>– Suitable for determining the compressor oil change intervals</li> </ul>	<ul style="list-style-type: none"> <li>– Optimum utilisation of the service life of compressor oils</li> </ul>	<p>Suitable for all common types of synthetic or mineral oil-based compressor oils, with the exception of polyglycols.</p>

# KlüberEfficiencySupport services

## KlüberEfficiencySupport

### EfficiencyManager Online Service Portal

#### KlüberEnergy Energy Efficiency



Service for optimum energy efficiency of your lubricant application. Reports on concrete savings.

#### KlüberMaintain Maintenance optimisation



Support for your lubricant management and maintenance programmes such as TPM<sup>1)</sup> with regard to lubricants and the associated maintenance activities.

#### KlüberMonitor Higher productivity



We recommend optimisations to increase your productivity on the basis of tribological analyses of your application and bench tests.

### KlüberCollege – People Efficiency

The methodology was developed by Klüber Lubrication, is tried-and-tested and consists of a multi-stage, systematic approach. We identify your requirements together with you at an early stage to discover potential for optimisation.

The results can be displayed by means of our maintenance software **EfficiencyManager**, which is used by our specialists to efficiently handle the processes relevant for production. The EfficiencyManager is an online portal combining all services offered by Klüber Lubrication and ensuring transparency among the ever more complex requirements in a smart factory.



<sup>1</sup> TPM: Total Productive Maintenance



# The right lubricant at the right place at the right time

## Systems for automatic lubrication

We at Klüber Lubrication understand ourselves as a solution provider. We not only supply high-performance oils and greases, but also “intelligent packages” for automatic lubrication of your machines and components. Selected lubricants covering a wide range of typical applications are available in automatic lubricant dispensers for single-point lubrication. These tried-and-tested systems based on electromechanical or electrochemical

technology are available with standard, long-term or high-pressure greases, standard or high-temperature chain oils and special oils and greases for the food-processing industry. We are also able to supply other lubricants in automatic dispensers on request and for higher order volumes, provided they have been tested and approved for use – please contact your Klüber Lubrication consultant for details.

## Your benefits at a glance

### Profitability

Continuous production processes and predictable maintenance intervals reduce production losses to a minimum. Consistently high lubricant quality ensures continuous, maintenance-free long-term lubrication for high plant availability. Continuous supply of fresh lubricant to the lubrication points keeps friction low and reduces energy costs.

→ **Lubrication with Klübermatic can reduce costs by up to 25 %**

### Safety

Longer lubrication intervals reduce the frequency of maintenance work and the need for your staff to work in danger zones. Lubrication systems from Klüber Lubrication can therefore considerably reduce occupational safety risks in work areas that are difficult to access.

→ **Lubrication with Klübermatic can decrease the risk of accidents by up to 90 %**

### Reliability



Automatic lubrication systems from Klüber Lubrication ensure reliable, clean and precise lubrication around the clock. Plant availability is ensured by continuous relubrication of the application.

→ **Lubrication with Klübermatic may help to prevent up to 55 % of rolling bearing failures**

### From low-cost to high-tech – automatic systems for all requirements

Klüber Lubrication offers you the following technological solutions:

- freely adjustable lubrication increments between 1 and 12 months
- range of speciality lubricants
- self-contained or machine-controlled lubrication systems (time control with programmable controller)
- combination of tried-and-tested Klüber Lubrication lubricants with proven automatic lubricant dispensers

Klübermatic FLEX	Klübermatic NOVA	Klübermatic STAR VARIO	Klübermatic STAR CONTROL
			
Flexible use – and for lubrication points with high requirements	For applications subject to wide temperature fluctuations	Precise and adjustable lubricant metering	Externally controlled single-point relubrication



Publisher and Copyright:  
Klüber Lubrication München SE & Co. KG

Reprints, total or in part, are permitted only prior consultation with Klüber Lubrication München SE & Co. KG and if source is indicated and voucher copy is forwarded.

The data in this document is based on our general experience and knowledge at the time of publication and is intended to give information of possible applications to a reader with technical experience. It constitutes neither an assurance of product properties nor does it release the user from the obligation of performing preliminary field tests with the product selected for a specific application. All data are guide values which depend on the lubricant's composition, the intended use and the application method. The technical values of lubricants change depending on the mechanical, dynamical, chemical and thermal loads, time and pressure. These changes may affect the function of a component. We recommend contacting us to discuss your specific application. If possible we will be pleased to provide a sample for testing on request. Products from Klüber Lubrication are continually improved. Therefore, Klüber Lubrication reserves the right to change all the technical data in this document at any time without notice.

Klüber Lubrication München SE & Co. KG  
Geisenhausenerstraße 7  
81379 München  
Germany

Local first-instance court Munich, Germany  
Certificate of registration 46624

**Image sources:**

Page 1: © alswart; stock.adobe.com

Page 36: © Evgeny Korshenkov; www.fotolia.com

Page 36: © luchshen; www.fotolia.com

[www.klueber.com](http://www.klueber.com)

## Klüber Lubrication – your global specialist

Innovative tribological solutions are our passion. Through personal contact and consultation, we help our customers to be successful worldwide, in all industries and markets. With our ambitious technical concepts and experienced, competent staff we have been fulfilling increasingly demanding requirements by manufacturing efficient high-performance lubricants for 90 years.